

08/2021

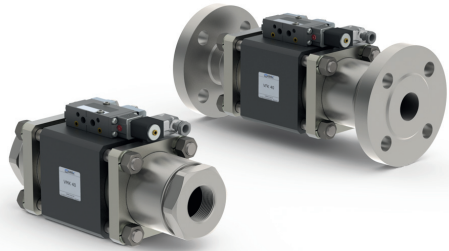

⚠ Above stated body materials refer to the valve port connections that get in contact with the media only!

details needed for main valve

- orifice
- port
- function NC/NO
- operating pressure
- flow rate
- media
- media temperature
- ambient temperature
- type of actuation

details needed for pneumatic actuation

- nominal voltage
- type of protection
- actuation pressure range min/max
- pilot valve type

details needed for hydraulic actuation

- actuation pressure range min/max
- hydraulic control valve function

⚠ The valves' technical design is based on media and application requirements. This can lead to deviations from the general specifications shown on the data sheet with regards to the design, sealing materials and characteristics.

⚠ If order or application specifications are incomplete or imprecise there exists a risk of an incorrect technical design of the valve for the required application. As a consequence, the physical and / or chemical properties of the materials or seals used, may not be suitable for the intended application.

2/2-way valve

pressure range
orifice
connection
function

design

body materials

valve seat

seal materials

ports

function
pressure range

Kv value
vacuum
pressure-vacuum

back pressure
media

abrasive media
damping

flow direction
switching cycles
switching time

media temperature
ambient temperature
flush ports
leak ports
limit switches
manual override
approvals
mounting
weight
additional equipment

nominal voltage

power consumption

protection
energized duty rating
connection
optional additional equipment
max. temperature

explosion proof

actuation pressure range
air consumption
cycle speed
control
pilot valve interface
actuator ports

actuation pressure range
control
actuator ports
by media

externally controlled

PN 0-100 bar
DN 40 mm
thread/flange

valve normally closed
symbol **NC**

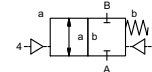

valve normally open
symbol **NO**

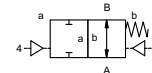

pressure balanced, with spring return

- ①
- ② steel galvanized
- ③
- ④ steel, nickel plated
- ⑤ without non-ferr. Metals
- ⑥ stainless steel

synthetic resin on metal

NBR PTFE, FPM, CR, EPDM

general specifications

VMK threads G 1 1/2 - G 2
VFK flanges PN 100
bar NC
0-64 / 0-100

options

special threads
special flanges
NO
> 100 bar upon request

m³/h 31,0
leak rate < 10⁻⁶ mbar•L•s⁻¹
P₁ ⇔ P₂ pressure side max. 100 bar
vacuum side leak rate upon request
available (max. 16 bar)
P₂ > P₁ gaseous - liquid - highly viscous -
gelatinous - pasty - contaminated

opening closing by throttles on pilot valve
A ⇔ B as marked
1/min 150
ms opening 100-3000
closing 100-3000

°C direct mounted pilot valve 60 remote mounted pilot valve outside
°C direct mounted pilot valve 50 temperatur range of media max. 160 °C
available
available
inductive / mechanical upon request
via pilot valve

kg VMK 11,2 VFK 13,6
LR/GL/WAZ
mounting brackets
upon request

electrical specifications

U_n DC 24 V
U_n AC 230 V 50 Hz
DC 4,8 W
AC pick up 11,0 VA holding 8,5 VA
IP65 (P54) acc. DIN 40050
ED 100%

options

special voltage upon request
special voltage upon request
2,5 W (actuation pressure range 4-7 bar)

M12x1 plug acc. DIN EN 175301-803 form B, 4 positions x90° / wire diameter 6-8 mm
connector acc. DESINA
illuminated plug with varistor
connector acc. VDMA

media 60°C
ambient 50°C
E Ex e II T5 nominal voltage U_n DC 24 V 3,25 W
power consumption AC 230 V 50 Hz 2,90 W

pneumatic specifications

bar 4-10
cm³/stroke 65
main valve speed variable by throttleson pilot valve
preferably 5/2 way pilot valve
co-ax / Namur ISO 1
2/4 G 1/8 G 1/4

options

hydraulic specifications

bar 15-30 / 30-60
X/Y G 1/4 preferably 4/2 way control valve
NPT 1/4

options

■ specifications not highlighted are standard
■ specifications highlighted in grey are optional

coax® data sheet - coaxial valve

type VMK 40
VFK 40

function: **NC**
closed when not energized

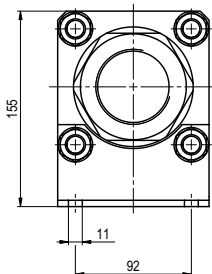
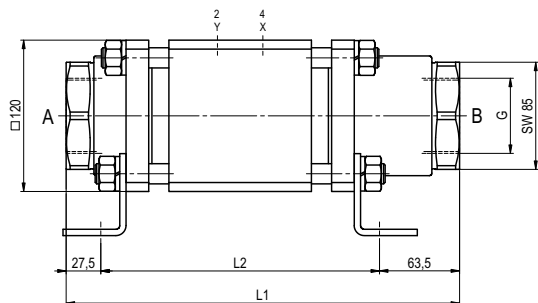

constructive length	L1	L2	L3
standard	312	221	385
with inductive limit switches	312	221	385
with force-feed lubrication nipple	312	221	385
with mechanical limit switches	-	-	-

flanges PN	DIN	ØD	Øk	Ød
100	EN 1092-1	170	125	22

function: **NO**
open when not energized

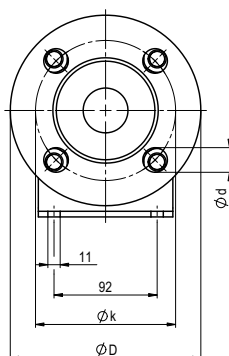
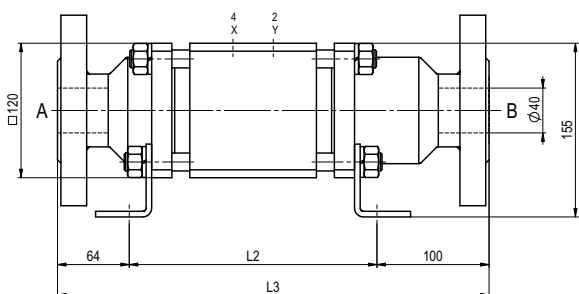

pneumatic specifications

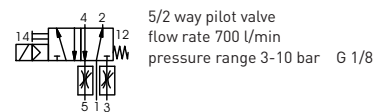

5/2 way pilot valve
flow rate 700 l/min
pressure range 3-10 bar G 1/8

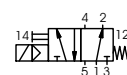

5/2 way pilot valve ISO 1
flow rate 700 l/min
pressure range 3-10 bar G 1/4