

LEO5

High-resolution digital manometer

Features

- Maximum accuracy
- Insulated piezoresistive pressure sensor encapsulated
- Robust, watertight stainless steel housing with safety glass front
- Large, backlit LC display
- Integrated rechargeable battery (USB chargeable)
- Free of license costs KELLER software as download

Functions

- High-resolution pressure measurements
- Pressure peak detection with 5 kHz sampling frequency
- Data logger
- Operated via capacitive touch keys
- Bar graph display
- Temperature display
- Min/max display

Typical Applications

- Pressure testing
- Calibration
- Laboratory use
- Industrial applications



Accuracy

± 0,05 %FS

Total Error Band

± 0,1 %FS

Pressure Ranges

-1...1 bar to 0...1000 bar

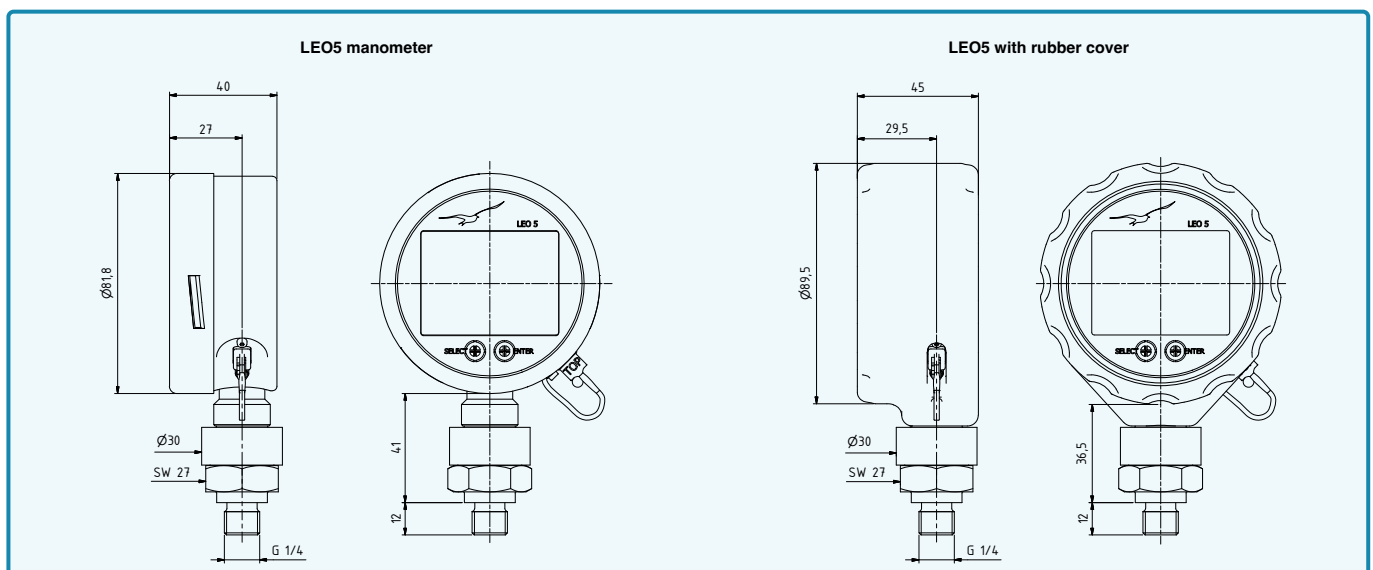

LEO5 – Specifications

Standard Pressure Ranges

Gauge pressure PR	Absolute pressure PAA	Absolute pressure PA	Overload resistance	Display resolution
-1...1	0...2		8	0,0001
-1...3	0...4		8	
-1...6	0...7		20	0,001
-1...10	0...11		20	
-1...16	0...17		40	
-1...30	0...31		60	
	0...61		200	
	0...101		200	0,01
	0...161		300	
		0...300	600	
		0...400	800	0,02
		0...700	1100	0,05
		0...1000	1100	0,1
bar rel.	bar abs.	bar abs.	bar	bar
Reference pressure at atmospheric pressure	Reference pressure at 0 bar abs. (vacuum)	Reference pressure at 1 bar abs.	Based on reference pressure	

Performance

Accuracy @ RT (20...25 °C)	$\leq \pm 0,05$ %FS	Nonlinearity (BFSL), pressure hysteresis, non-repeatability, zero point deviation and amplification deviation
Total error band (0...50 °C)	$\leq \pm 0,1$ %FS	Max. deviation within the specified pressure and temperature range
Compensated temperature range	0...50 °C	
Long-term stability	$\leq \pm 0,1$ %FS	Per year under reference conditions, yearly recalibration recommended
Degree of dependency on location	$\leq \pm 1,5$ mbar	Calibrated in vertical installation position with pressure connection facing downwards
Accuracy of temperature measurement	± 1 °C typ.	
Pressure range reserve	$\pm 10\%$	Valid measured values outside the pressure range, no overflow / underflow yet
Vacuum endurance	$\leq 0,2$ bar abs.	Of operation $\leq 0,2$ bar abs. upon request

Electrical Data

Rechargeable battery	Lithium-ion 4,2 V / 2,3 Ah
Battery life (standard)	Up to 2000 hours of continuous operation
Battery life (peak mode)	Up to 160 hours of continuous operation
Battery charging cycles	> 300
GND case insulation	> 10 M Ω @ 300 VDC
External interface	USB (KELLER protocol)
Interface measuring rate	2/s
Electrical connection	Mini USB-B

Electromagnetic compatibility

CE conformity as per 2014/30/EU (EMV)	EN 61326-1 / EN 61326-2-3 / EN 61000-6-1 / EN 61000-6-2 / EN 61000-6-3 / EN 61000-6-4
---------------------------------------	---

LEO5 – Specifications

Electrical Data

Data logger

Cyclical logger	Recording of pressure and temperature	Various recording functions can be configured
Data storage	≥ 56 000 measured values with timestamp	
Recording modes	Interval, event-controlled	
Storage interval	≥ 1/s, can be configured in 1-second increments	

Display

Dimensions/appearance	Width × height: 51,3 mm × 38,8 mm, also refer to Dimensions and options	
Number of digits on LC display	2 rows with 5 digits each	
Display mode	Pressure + min/max or pressure + temperature, additional bar graph	
Measuring rate (standard)	2/s	
Measuring rate (peak mode)	5000/s (reduced resolution and accuracy)	
Configurable units of pressure	bar, mbar, Pa, hPa, kPa, MPa, PSI, mH ₂ O, cmH ₂ O, inH ₂ O, ftH ₂ O, mmHg, inHg, kp/cm ²	
Additional units of pressure	5 user-defined units can be configured	

Mechanical Data

Materials in contact with media

Pressure connection	Stainless steel AISI 316L	Others on request
Pressure transducer separating diaphragm	Stainless steel AISI 316L	
Pressure transducer seal (internal)	FKM	
Pressure connection seal (external)	FKM	Others on request

Other materials

Display housing	Stainless steel AISI 304
Front glass	LEXAN® 163R
Oil filling pressure transducer	Silicone oil

Further details

Pressure connection	G1/4 male	Other options see available pressure connections
Diameter × height × depth	Approx. 82 mm × 135 mm × 40 mm	Without rubber cover
	Approx. 90 mm × 139 mm × 45 mm	With rubber cover
Weight	Approx. 430 g	

Environmental conditions

Medium temperature range	-40...85 °C	Icing not permitted
Ambient temperature range	-10...60 °C	
Storage temperature range	-20...70 °C	
Protection	IP65	
Note	Readability of the LC display is guaranteed between 0 °C and 50 °C Outside of this temperature range, the readability of the display may be limited	

LEO5 – Dimensions and Options

LC Display

Front cover	Content	Dimensions
		Width x height: 51,3 mm x 38,8 mm Digit size: top: 15 mm x 7 mm bottom: 10,5 mm x 4,5 mm

External Connection

Placement	Mini USB-B connection

Available Pressure Connections

G1/4 (standard)	G1/2 front flush	1/4-18NPT	1/2-14NPT	G1/2 mano
DIN EN ISO 1179-2	DIN EN ISO 1179-2	ASME/ANSI B 1.20.1	ASME/ANSI B 1.20.1	DIN EN 837-1
G1/2 front flush	G3/4 front flush	7/16-20 UNF	Tri-Clamp 1 1/2"	G1/4 mano
EN ISO 228-1	EN ISO 228-1	ISO 12151-5	DIN 32676	DIN EN 837-1

Other pressure connections available upon request.

Optional Advanced Versions

Standard	Detached sensors

Other Customer-specific Options

- Other compensated pressure ranges
- Other compensated temperature ranges
- Parts that come into contact with media made from Hastelloy, Inconel or titanium
- Customer-specific front covers
- Customer-specific firmware with e.g. application-specific calculations
- Other sealing materials for pressure transducers
- Other oil fillings for pressure transducers

LEO5 – Software, Scope of Delivery and Accessories

Interface

The LEO5 manometer has a USB interface. Details of the communication protocols can be found at www.keller-druck.com. Documentation, a Dynamic Link Library (DLL) and various programming examples are available to integrate the communication protocol into your own software.

KOLIBRI Desktop

With the «KOLIBRI Desktop» Windows software, data recorded using KELLER instruments with a recording function can be read and visualised. This data can be exported in CSV, JSON, Excel or Word format, as an image, or in other formats for further processing or documentation. The data loggers are easy to configure, thanks to the intuitive software interface. And, the various recording functions provide an optimum level of adaptability to suit the measuring task at hand. Additionally, installation site information and other parameters necessary for water level calculations can be saved directly in the measuring device.

KOLIBRI Desktop is license-free and compatible with all products of the KOLIBRI Suite

Configuration options

- Pressure and temperature channels, selectable.
- Adjustable measurement interval (1s...99 days)
- Averaging with selectable number of measurements
- Recording modes
 - continuous interval measurement
 - event-controlled recording
 - recording starts when value is exceeded
 - recording starts when value is undercut
 - recording starts when value changes
 - combination of continuous and event-controlled recording is possible
- Adjustment of pressure zero point
- Start measurements immediately or at a set time
- Water level calculation
- Data storage: linear or ring-type memory



«CCS30» Software

Recording measured values

- Live visualisation
- Adjustable measuring and storage interval
- Export function

Configuration

- Call up of information (pressure and temperature range, firmware version, serial number etc.)

«ManoConfig» Software





The ManoConfig program is compatible with various types of KELLER manometers and allows end customers to configure the devices.

Range of functions



- Display of online measured values
- Configuring the wait period before automatic shutdown
- Selecting standard pressure units
- Activating/deactivating pressure units
- Programming user-defined pressure units
- Restoring to factory settings
- Calibrating the manometer

LEO5 – Software, Scope of Delivery and Accessories

Scope of Delivery

Plastic case	USB cable	KELLER 5-point report	Operating instructions D/E/F
			

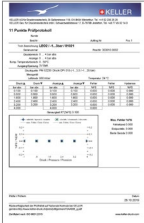
Accessories

Rubber cover	KELLER 11-point report	Calibration certificate
		
For additional protection in harsh environments	Measurement deviation at room temperature with hysteresis	Issued by the external calibration laboratory of the German accreditation body DAkkS or the Swiss accreditation body SAS