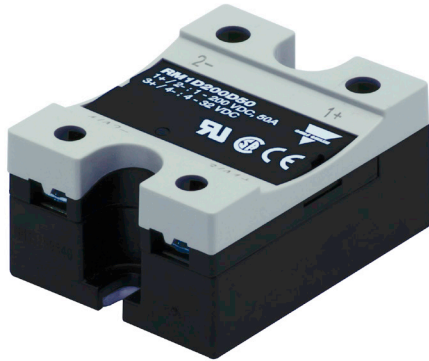


# RM1D



## DC switching solid state relays



### Main features

- Low power dissipation output Mosfet
- 100 ADC maximum output current up to 60 VDC
- 50 ADC maximum output current up to 200 VDC
- 10 ADC maximum output current up to 500 VDC
- Switching frequency up to 1000 Hz
- 4-32 VDC control voltage range
- LED for control presence indication
- Clip-on IP 20 protection cover
- Self-lifting terminals
- Housing free of moulding mass

### Description

The **RM1D** series expands Carlo Gavazzi's range of DC solid state switching solutions up to 100 A for supply voltages up to 60 VDC, up to 50 A for supply voltages of maximum 200 VDC and up to 10 A for supply voltages of maximum 500 VDC. This new range is suitable for panel mounting or for mounting on a heatsink. The switching of the **RM1D** is controlled by a DC voltage in the range of 4 to 32 V. An LED indicates control voltage presence on the SSR.

The **RM1D** is the ideal solution when switching response times, from ON to OFF and vice versa, are critical to the application. Being fully solid state, the **RM1D** is the obvious choice for applications necessitating a high number of switching cycles since the SSR lifetime is not compromised by such switching.

Specifications are at a surrounding temperature of 25°C unless otherwise specified.

### Applications

DC heaters, Solenoid valves, Test equipment, Connection and disconnection of battery sources

### Main features

- DC switching solid state relay with 3750 Vrms isolation between input and output
- Fast response times to switch ON and OFF
- Fully solid state to ensure trouble free operation over a high number of switching cycles

**Order code**

**RM1D  D**

Enter the code entering the corresponding option instead of . Refer to selection guide section for valid part numbers.

Code	Option	Description	Comments	
R	-	Solid state relay (RM)		
M	-			
1	-		1-pole switching	
D	-		DC switching	
<input type="checkbox"/>	060	Rated output voltage: 60 VDC (1-60 VDC)		
	200	Rated output voltage: 200 VDC (1-200 VDC)		
	500	Rated output voltage: 500 VDC (1-500 VDC)		
D	-	Control voltage: 4-32 VDC	4.5-32 VDC for RM1D200.., RM1D500..	
<input type="checkbox"/>	10	Max. rated current (with heatsink): 10 ADC	Not available with RM1D200D..	
	20	Max. rated current (with heatsink): 20 ADC	Not available with RM1D500D..	
	50	Max. rated current (with heatsink): 50 ADC	Not available with RM1D500D..	
	100	Max. rated current (with heatsink): 100 ADC	Available only with RM1D060D..	
HT	-	Pre- attached thermal pad	Option, available on request	

**Selection guide**

Rated output voltage	Control voltage	Maximum rated operational current*			
		10 ADC	20 ADC	50 ADC	100 ADC
1-60 VDC	4-32 VDC	RM1D060D10	RM1D060D20	RM1D060D50	RM1D060D100
1-200 VDC	4.5-32 VDC	-	RM1D200D20	RM1D200D50	-
1-500 VDC		RM1D500D10	-	-	-

\* Refer to Heatsink selection tables

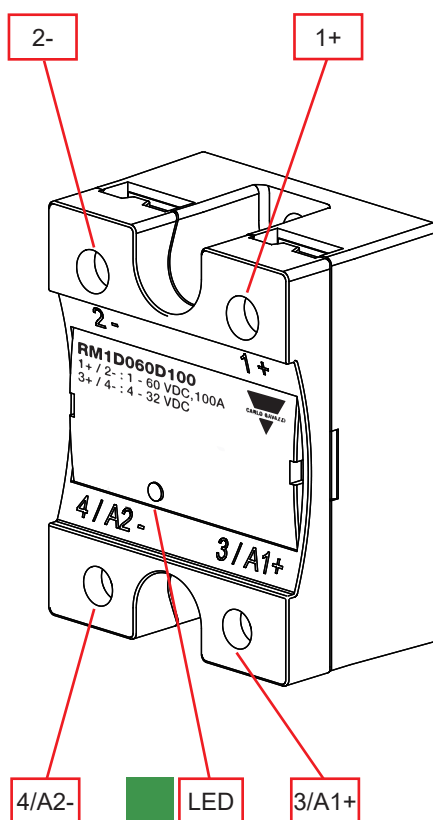
**Carlo Gavazzi compatible components**

Purpose	Component name/code	Notes
Heatsinks	RHS	Heatsinks and fans
Screws kits for SSR mounting	SRWKITM5X10MM	Packing qty.: 20 pcs.
Fork terminals	RM635KP	Packing qty.: 10 pcs.
Touch protection covers	RMIP20	Packing qty.: 10 pcs.
Thermal pads	KK071CUT	Packing qty.: 50 pcs.

**Further reading**

Information	Where to find it
Online heatsink selector tool	<a href="http://gavazziautomation.com/nsc/hq/en/solid_state_relays">http://gavazziautomation.com/nsc/hq/en/solid_state_relays</a>

## Structure



Element	Component	Function
1+	Power connection	Load connection or positive supply connection
2-	Power connection	Load connection or ground supply connection
3/A1+	Control connection	Control supply signal
4/A2-	Control connection	Ground connection for control
LED	Control indication	Indicates presence of control voltage

# Features

## General data

<b>Housing material</b>	Noryl, black
<b>Mounting</b>	Panel mount
<b>Touch Protection</b>	IP20
<b>Isolation</b>	Input and output to case: 3750 Vrms Input to output: 3750 Vrms
<b>Weight</b>	approx. 83 g
<b>LED indication</b>	Continuously ON green LED when control input is applied

## Dimensions

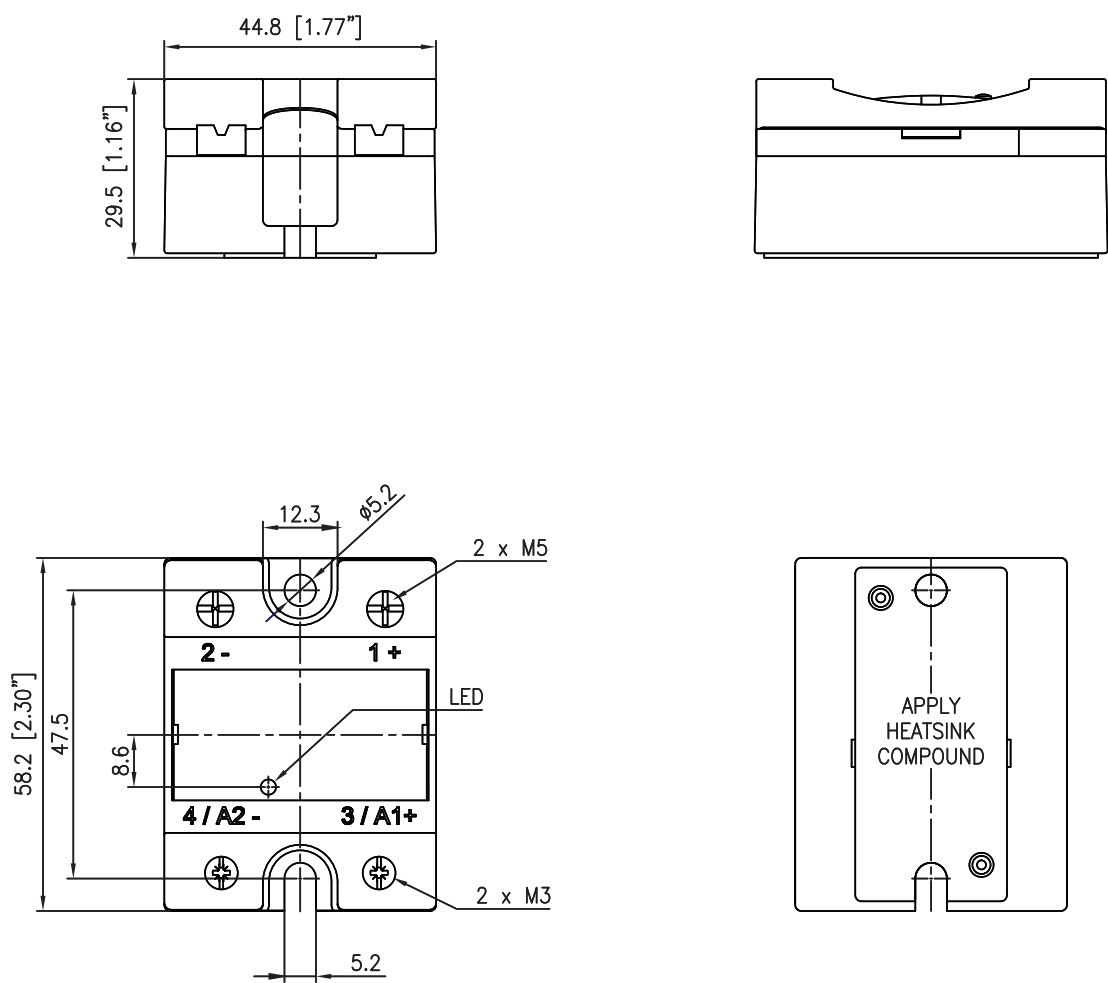


Fig. 1 RM1D dimensions

Dimensions in mm unless otherwise noted

# Performance

## Outputs

	RM1D060..				RM1D200..		RM1D500..
Max. operational current: DC 1 rating	10 ADC	20 ADC	50 ADC	100 ADC	20 ADC	50 ADC	10 ADC
Absolute max. output voltage	60 VDC				200 VDC		500 VDC
Operational voltage range, Ue	1-60 VDC				1-200 VDC	1-200 VDC (150 VDC*)	1-500 VDC
Output protection	Integrated transil						
Leakage current @ rated voltage	0.1 mADC						
Minimum operational current	5 mADC						
Repetitive overload current UL508: T <sub>AMB</sub> =40°C, t <sub>ON</sub> =1 s, t <sub>OFF</sub> =9 s, 50 cycles	15 ADC	30 ADC	75 ADC	150 ADC	30 ADC	75 ADC	15 ADC

\* Please refer to note found in the Connection diagrams section

## Inputs

	RM1D060..	RM1D200.. RM1D500..
Control voltage range	4-32 VDC	4.5-32 VDC
Pick-up voltage <sup>1</sup>	4 VDC	4.5 VDC
Drop-out voltage	1.2 VDC	
Maximum reverse voltage	32 VDC	
Maximum switching frequency <sup>2</sup>	1000 Hz	
Response time pickup @ V <sub>out</sub> = 24 VDC, t <sub>on</sub> <sup>3</sup>	≤100 μs	
Response time drop-out, t <sub>off</sub> <sup>3</sup>	≤100 μs	≤150 μs
Input current @ 40°C	<16 mADC	

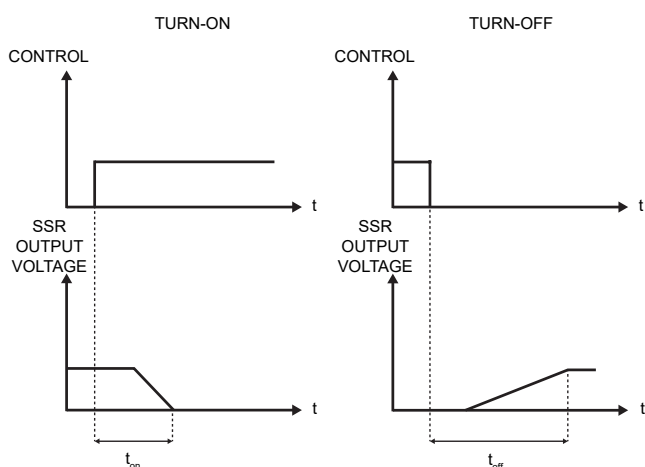


Fig. 2 Response time characteristics

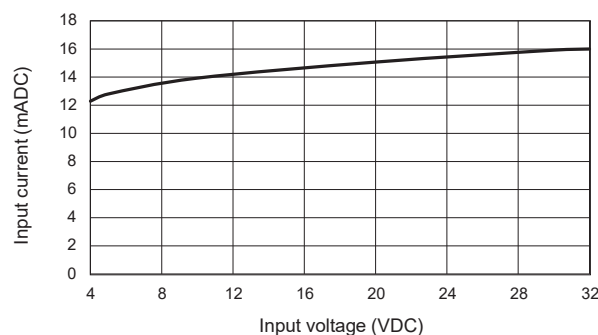


Fig. 3 Input voltage vs. input current curve

- 1: Pick-up voltage increases to 5.5 VDC at operating temperatures lower than -20°C
- 2: Output current has to be derated at high switching frequencies. Refer to the Current derating vs. switching frequency section
- 3: Response times will be longer for lower output voltages (<24 VDC)

**Current derating vs switching frequency**

RM1D060D..

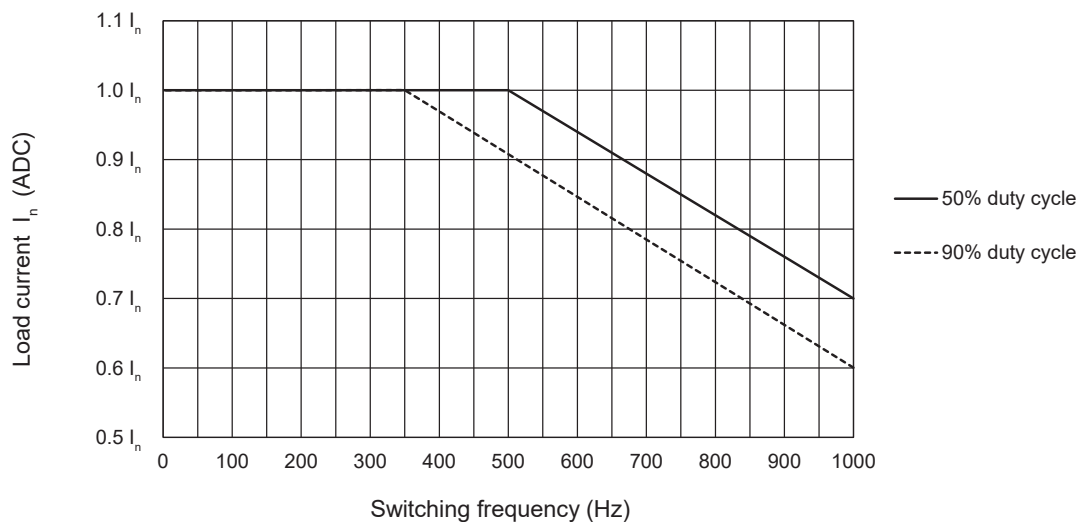


Fig. 4 Current derating vs. switching frequency

RM1D200D..

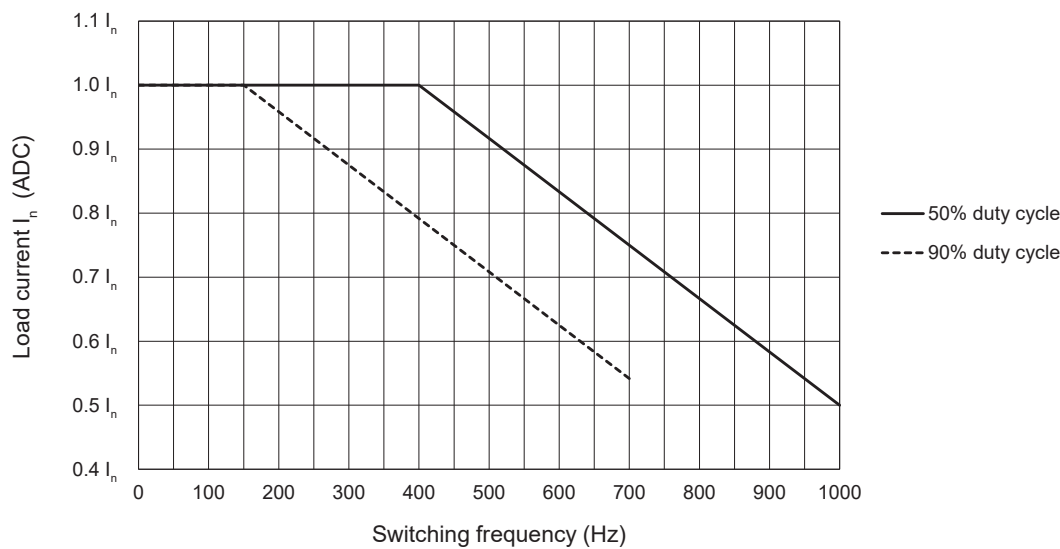


Fig. 5 Current derating vs. switching frequency<sup>4</sup>

## Current derating vs switching frequency (continue)

RM1D500D..

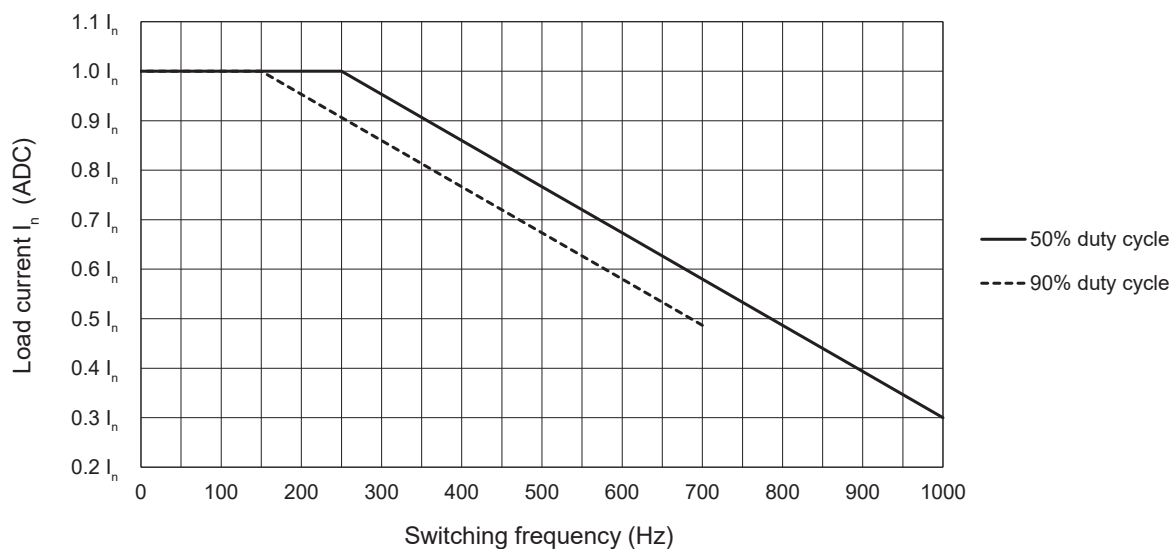
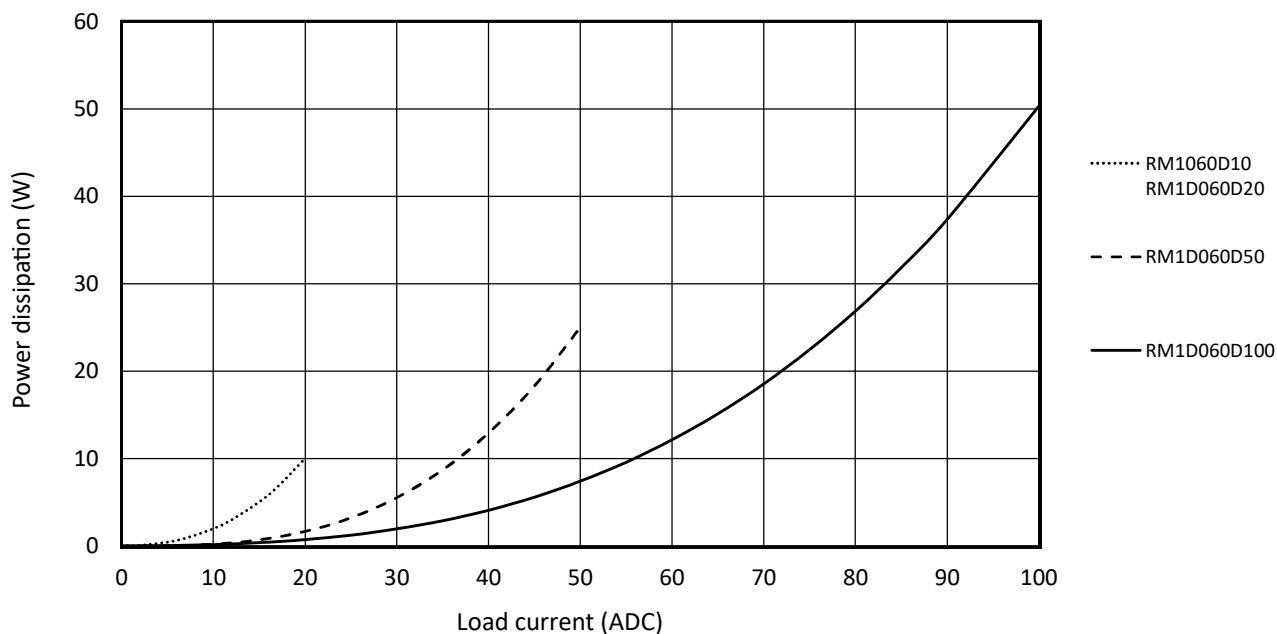


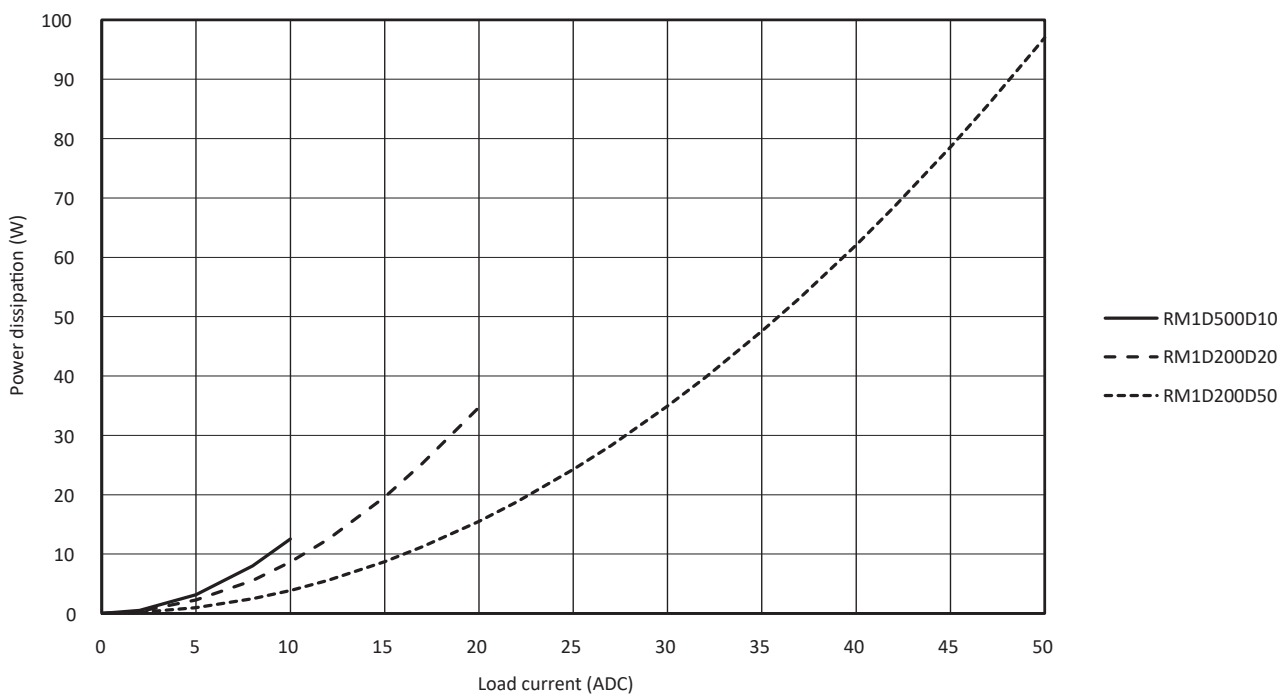
Fig. 6 Current derating vs. switching frequency<sup>4</sup>

4. At 90% duty cycle, the switching frequency for the RM1D200D.. and RM1D500D.. is limited to 700 Hz. This limitation is related to the response time drop out of  $150 \mu\text{s}$  for these models. For example:
- OFF time at a switching frequency of 800Hz with 90% duty cycle is  $125 \mu\text{s}$ , that is lower than the time needed for the SSR to switch OFF ( $150 \mu\text{s}$ ) so the SSR output would not switch OFF
  - OFF time at a switching frequency of 600Hz with 90% duty cycle is  $167 \mu\text{s}$  which is greater than the time needed for the SSR to switch OFF ( $150 \mu\text{s}$ )

**Output power dissipation**



**Fig. 7** Output power dissipation graph



**Fig. 8** Output power dissipation graph



**Heatsink selection**

Note: The heatsink selection in tables below is valid only when a fine layer of silicon based thermal paste (with a similar thermal resistance to that specified for  $R_{thcs}$  in the Thermal data section) is utilised. The SSR will overheat if this heatsink selection is used for heatsink assemblies using a thermal interface material having a higher  $R_{thcs}$  than indicated in the Thermal data section.

Thermal resistance [°C/W] of RM1D060D10, RM1D060D20

Load current [A]	Surrounding ambient temperature [°C]						
	20	30	40	50	60	70	80
20	nh	14.0	9.7	6.4	3.8	1.8	-
18	nh	nh	14.0	8.9	5.2	2.5	0.25
16	nh	nh	nh	13.3	7.5	3.5	0.51
14	nh	nh	nh	nh	11.4	5.1	0.92
12	nh	nh	nh	nh	nh	8.0	1.6
10	nh	nh	nh	nh	nh	14.3	2.7
8	nh	nh	nh	nh	nh	nh	5.0
6	nh	nh	nh	nh	nh	nh	11.5
4	nh	nh	nh	nh	nh	nh	nh
2	nh	nh	nh	nh	nh	nh	nh

Thermal resistance [°C/W] of RM1D060D50

Load current [A]	Surrounding ambient temperature [°C]						
	20	30	40	50	60	70	80
50	4.3	3.3	2.4	1.6	0.9	0.22	-
45	6.0	4.6	3.4	2.3	1.3	0.47	-
40	8.8	6.7	4.9	3.3	2.0	0.82	-
35	14.3	10.3	7.4	5.0	3.0	1.3	-
30	nh	18.7	12.3	8.0	4.7	2.2	0.18
25	nh	nh	nh	14.8	8.2	3.8	0.59
20	nh	nh	nh	nh	17.5	7.2	1.4
15	nh	nh	nh	nh	nh	18.5	3.2
10	nh	nh	nh	nh	nh	nh	10.3
5	nh	nh	nh	nh	nh	nh	nh

Note: 'nh' means no heatsink necessary. The SSR should still be tightened to a surface to ensure optimal thermal dissipation.

**Heatsink selection (cont.)**

Thermal resistance [°C/W] of RM1D060D100

Load current [A]	Surrounding ambient temperature [°C]						
	20	30	40	50	60	70	80
100	1.8	1.4	1.1	0.73	0.4	-	-
90	2.4	1.9	1.5	1.0	0.6	0.21	-
80	3.3	2.7	2.0	1.4	0.88	0.37	-
70	4.8	3.8	2.9	2.1	1.3	0.61	-
60	7.6	5.9	4.4	3.1	2.0	0.98	-
50	14.0	10.2	7.4	5.1	3.2	1.6	0.27
40	nh	nh	15.5	9.9	5.9	2.9	0.64
30	nh	nh	nh	nh	14.2	6.3	1.5
20	nh	nh	nh	nh	nh	nh	4.2
10	nh	nh	nh	nh	nh	nh	nh

Thermal resistance [°C/W] of RM1D200D20

Load current [A]	Surrounding ambient temperature [°C]						
	20	30	40	50	60	70	80
20	3.4	2.8	2.2	1.7	1.2	0.71	0.27
18	4.8	3.9	3.1	2.4	1.7	1.1	0.53
16	7.1	5.7	4.5	3.4	2.5	1.7	0.91
14	11.5	9.0	6.9	5.2	3.8	2.6	1.5
12	nh	16.1	11.7	8.5	6.1	4.1	2.4
10	nh	nh	nh	16.3	10.6	6.7	3.9
8	nh	nh	nh	nh	nh	13.5	7.0
6	nh	nh	nh	nh	nh	nh	17.5
4	nh	nh	nh	nh	nh	nh	nh
2	nh	nh	nh	nh	nh	nh	nh

Thermal resistance [°C/W] of RM1D200D50

Load current [A]	Surrounding ambient temperature [°C]						
	20	30	40	50	60	70	80
50	1.1	1.0	0.79	0.60	0.42	0.24	-
45	1.6	1.4	1.1	0.86	0.62	0.39	0.17
40	2.3	1.9	1.6	1.2	0.92	0.62	0.33
35	3.4	2.8	2.3	1.8	1.4	1.0	0.55
30	5.3	4.4	3.5	2.8	2.1	1.5	0.92
25	9.3	7.5	5.9	4.6	3.4	2.4	1.5
20	nh	16.5	11.9	8.7	6.2	4.2	2.5
15	nh	nh	nh	nh	15.6	9.2	5.1
10	nh	nh	nh	nh	nh	nh	17.5
5	nh	nh	nh	nh	nh	nh	nh

Note: 'nh' means no heatsink necessary. The SSR should still be tightened to a surface to ensure optimal thermal dissipation.

**Heatsink selection (cont.)**

Thermal resistance [°C/W] of RM1D500D10

Load current [A]	Surrounding ambient temperature [°C]						
	20	30	40	50	60	70	80
10	10.7	8.3	6.4	4.7	3.3	2.2	1.1
9	17.0	12.6	9.4	6.8	4.8	3.1	1.7
8	nh	nh	14.8	10.4	7.2	4.6	2.6
7	nh	nh	nh	17.3	11.1	7.0	4.1
6	nh	nh	nh	nh	nh	11.3	6.1
5	nh	nh	nh	nh	nh	nh	10.2
4	nh	nh	nh	nh	nh	nh	nh
3	nh	nh	nh	nh	nh	nh	nh
2	nh	nh	nh	nh	nh	nh	nh
1	nh	nh	nh	nh	nh	nh	nh

Note: 'nh' means no heatsink necessary. The SSR should still be tightened to a surface to ensure optimal thermal dissipation.

**Heatsink selection for variants with pre-attached thermal pad**

Note: The heatsink selection in tables below is valid for the models having a pre-attached thermal interface (RM1D..HT). The thermal resistance  $R_{thcs\_HT}$  of the interface used is noted in the Thermal data section (ref. KK071CUT). In case of replacements, a thermal interface pad having the same or lower thermal resistance shall be utilised to prevent SSR from overheating.

Thermal resistance [°C/W] of RM1D060D10HT, RM1D060D20HT

Load current [A]	Surrounding ambient temperature [°C]						
	20	30	40	50	60	70	80
20	nh	13.7	9.3	6.0	3.5	1.4	-
18	nh	nh	13.7	8.6	4.9	2.1	-
16	nh	nh	nh	12.9	7.1	3.1	0.16
14	nh	nh	nh	nh	11.0	4.7	0.57
12	nh	nh	nh	nh	19.8	7.6	1.2
10	nh	nh	nh	nh	nh	14.0	2.3
8	nh	nh	nh	nh	nh	nh	4.7
6	nh	nh	nh	nh	nh	nh	11.1
4	nh	nh	nh	nh	nh	nh	nh
2	nh	nh	nh	nh	nh	nh	nh

Note: 'nh' means no heatsink necessary. The SSR should still be tightened to a surface to ensure optimal thermal dissipation.

**Heatsink selection for variants with pre-attached thermal pad (cont.)**

Thermal resistance [°C/W] of RM1D060D50HT

Load current [A]	Surrounding ambient temperature [°C]						
	20	30	40	50	60	70	80
50	4.0	3.0	2.1	1.3	0.55	-	-
45	5.7	4.3	3.0	2.0	1.0	0.12	-
40	8.5	6.3	4.5	3.0	1.6	0.47	-
35	13.9	10.0	7.0	4.6	2.6	1.0	-
30	nh	18.3	12.0	7.6	4.4	1.9	-
25	nh	nh	nh	14.4	7.8	3.4	0.24
20	nh	nh	nh	nh	17.2	6.8	1.0
15	nh	nh	nh	nh	nh	18.2	2.9
10	nh	nh	nh	nh	nh	nh	10.0
5	nh	nh	nh	nh	nh	nh	nh

Thermal resistance [°C/W] of RM1D060D100HT

Load current [A]	Surrounding ambient temperature [°C]						
	20	30	40	50	60	70	80
100	1.4	1.1	0.71	0.38	-	-	-
90	2.1	1.6	1.1	0.66	0.25	-	-
80	3.0	2.3	1.7	1.1	0.53	-	-
70	4.5	3.5	2.6	1.7	1.0	0.26	-
60	7.3	5.5	4.1	2.8	1.6	0.63	-
50	13.6	9.9	7.1	4.8	2.9	1.3	-
40	nh	nh	15.1	9.5	5.5	2.6	0.29
30	nh	nh	nh	nh	13.8	6.0	1.1
20	nh	nh	nh	nh	nh	nh	3.8
10	nh	nh	nh	nh	nh	nh	nh

Thermal resistance [°C/W] of RM1D200D20HT

Load current [A]	Surrounding ambient temperature [°C]						
	20	30	40	50	60	70	80
20	3.0	2.4	1.8	1.3	0.82	0.36	-
18	4.4	3.5	2.7	2.0	1.4	0.74	0.18
16	6.7	5.3	4.1	3.1	2.1	1.3	0.56
14	11.2	8.7	6.6	4.9	3.4	2.2	1.1
12	nh	16.2	11.7	8.4	5.8	3.7	2.1
10	nh	nh	nh	16.4	10.6	6.8	3.9
8	nh	nh	nh	nh	nh	13.7	7.1
6	nh	nh	nh	nh	nh	nh	17.7
4	nh	nh	nh	nh	nh	nh	nh
2	nh	nh	nh	nh	nh	nh	nh

Note: 'nh' means no heatsink necessary. The SSR should still be tightened to a surface to ensure optimal thermal dissipation.

**Heatsink selection for versions with thermal pad (cont.)**

Thermal resistance [°C/W] of RM1D200D50HT

Load current [A]	Surrounding ambient temperature [°C]						
	20	30	40	50	60	70	80
50	0.84	0.64	0.44	0.25	-	-	-
45	1.3	1.0	0.76	0.51	0.27	-	-
40	2.0	1.6	1.2	0.89	0.57	0.27	-
35	3.0	2.5	2.0	1.5	1.0	0.60	0.20
30	4.9	4.0	3.2	2.4	1.8	1.1	0.57
25	9.2	7.3	5.7	4.3	3.1	2.1	1.2
20	nh	16.5	12.0	8.7	6.2	4.2	2.5
15	nh	nh	nh	nh	15.7	9.3	5.2
10	nh	nh	nh	nh	nh	nh	17.8
5	nh	nh	nh	nh	nh	nh	nh

Thermal resistance [°C/W] of RM1D500D10HT

Load current [A]	Surrounding ambient temperature [°C]						
	20	30	40	50	60	70	80
10	10.4	8.0	6.0	4.4	3.0	1.8	0.76
9	16.8	12.3	9.0	6.5	4.4	2.8	1.4
8	nh	nh	14.8	10.1	6.8	4.3	2.3
7	nh	nh	nh	17.4	11.2	6.9	3.7
6	nh	nh	nh	nh	nh	11.4	6.1
5	nh	nh	nh	nh	nh	nh	10.4
4	nh	nh	nh	nh	nh	nh	nh
3	nh	nh	nh	nh	nh	nh	nh
2	nh	nh	nh	nh	nh	nh	nh
1	nh	nh	nh	nh	nh	nh	nh

Note: 'nh' means no heatsink necessary. The SSR should still be tightened to a surface to ensure optimal thermal dissipation.


**Thermal data**

	RM1D060D10 RM1D060D20 RM1D060D50	RM1D060D100	RM1D200D20	RM1D200D50	RM1D500D10
Max. junction temperature	175°C	175°C	150°C	150°C	150°C
Junction to case thermal resistance, $R_{thjc}$	1.2°C/W	0.6°C/W	0.9°C/W	0.45°C/W	1.5°C/W
Case to heatsink thermal resistance, $R_{thcs}^5$	0.2°C/W	0.2°C/W	0.1°C/W	0.1°C/W	0.2°C/W
Case to heatsink thermal resistance (RM1D..HT), $R_{thcs\_HT}^6$	0.55°C/W	0.55°C/W	0.55°C/W	0.55°C/W	0.55°C/W

5: Thermal resistance case to heatsink values are applicable upon application of a fine layer of silicon based thermal paste HTS02S from Electrolube between SSR and heatsink.

6: Thermal resistance case to heatsink values for RM1D..HT are applicable for the KK071CUT thermal pad that is pre-attached from the factory to the RM1D.

## Compatibility and conformance

Approvals	
Standard compliance	LVD: EN 60947-4-3 / EE: BS 60947-4-3 EMC: EN 61000-6-2, EN 61000-6-4 / EMC: BS 61000-6-2, BS 61000-6-4 UR: UL508, E80573, NRNT2 cUR: CSA 22.2 No. 14-18, E80573, NRNT8 CSA: CSA22.2 No. 14-18, 204075
UL short circuit current rating	5 kArms

### Electromagnetic compatibility (EMC) - Immunity

Electrostatic discharge (ESD)	EN/IEC 61000-4-2 8 kV air discharge, 4 kV contact (PC2)
Radiated radio frequency	EN/IEC 61000-4-3 10 V/m, from 80 MHz to 1 GHz (PC1) 10 V/m, from 1 GHz to 2.7 GHz (PC1)
Electrical fast transient (burst)	EN/IEC 61000-4-4 Output 5 kHz, 100 kHz: 2 kV (PC2) Input 5 kHz, 100 kHz: 1 kV (PC2)
Conducted radio frequency	EN/IEC 61000-4-6 10 V/m, from 0.15 to 80 MHz (PC1)
Electrical surge	EN/IEC 61000-4-5 Output, line to line: 1 kV (PC2) Output, line to earth: 1 kV (PC2) Input, line to earth: 1 kV (PC2)
Voltage dips	EN/IEC 61000-4-11 0% for 10, 20, 5000 ms (PC2) 40% for 200 ms (PC2) 70% for 500 ms (PC2) 80% for 5000 ms (PC2)
Voltage dips, short interruptions and voltage variations	EN/IEC 61000-4-29 0% for 1, 3, 10, 30, 100, 300, 1000 ms (PC2) 30% for 10, 30, 100, 300, 1000 ms (PC2) 40% for 10, 30, 100, 300, 1000 ms (PC2) 60% for 10, 30, 100, 300, 1000 ms (PC2) 70% for 10, 30, 100, 300, 1000 ms (PC2) 80% on min. 19.2 VDC for 10, 30, 100, 300, 1000, 3000, 10000 ms (PC2) 120% on min. 29.8 VDC for 10, 30, 100, 300, 1000, 3000, 10000 ms (PC2)

### Electromagnetic compatibility (EMC) - Emissions


Radio interference field emission (radiated)	EN/IEC 55011 Class B: from 0.15 to 30 MHz
Radio interference voltage emissions (conducted)	EN/IEC 55011 Class B: from 30 MHz to 1 GHz

#### Note:

Control input lines must be installed together (i.e. a 2 core cable) to maintain products' susceptibility to Radio Frequency interference

- Performance Criteria 1 (PC1): No degradation of performance or loss of function is allowed when the product is operated as intended.
- Performance Criteria 2 (PC2): During the test, degradation of performance or partial loss of function is allowed. However when the test is complete the product should return operating as intended by itself.

**Environmental specifications**

<b>Operating temperature</b>	-20°C to 80°C (-4°F to 176°F)
<b>Storage temperature</b>	-40°C to +100°C (-40°F to +212°F)
<b>Relative humidity</b>	95% non-condensing @ 40°C
<b>Pollution degree</b>	2
<b>Installation altitude</b>	0-1000 m. Above 1000 m derate linearly by 1% of FLC per 100 m up to a maximum of 2000 m
<b>Vibration resistance</b>	2g / axis
<b>EU RoHS compliant</b>	Yes
<b>China RoHS</b>	

The declaration in this section is prepared in compliance with People's Republic of China Electronic Industry Standard SJ/T11364-2014: Marking for the Restricted Use of Hazardous Substances in Electronic and Electrical Products.

Part Name	Toxic or Harardous Substances and Elements					
	Lead (Pb)	Mercury (Hg)	Cadmium (Cd)	Hexavalent Chromium (Cr(VI))	Polybrominated biphenyls (PBB)	Polybrominated diphenyl ethers (PBDE)
<b>Power Unit Assembly</b>	x	0	0	0	0	0
O: Indicates that said hazardous substance contained in homogeneous materials for this part are below the limit requirement of GB/T 26572. X: Indicates that said hazardous substance contained in one of the homogeneous materials used for this part is above the limit requirement of GB/T 26572.						

这份申明根据中华人民共和国电子工业标准 SJ/T11364-2014：标注在电子电气产品中限定使用的有害物质

零件名称	有毒或有害物质与元素					
	铅 (Pb)	汞 (Hg)	镉 (Cd)	六价铬 (Cr(VI))	多溴化联苯 (PBB)	多溴联苯醚 (PBDE)
功率单元	x	0	0	0	0	0
O:此零件所有材料中含有的该有害物低于GB/T 26572的限定。 X: 此零件某种材料中含有的该有害物高于GB/T 26572的限定。						

**Short circuit protection**

Part No.	Prospective short circuit current [kArms]	Ferraz Shawmut (Mersen)			Siba		
		Max fuse size [A]	Part number	Voltage Rating [VDC]	Max fuse size [A]	Part number	Voltage Rating [VDC]
RM1D060D10	5	15	A4J15	300	16	5019006.16	660
RM1D060D20		25	A4J25		25	5019006.25	
RM1D060D50		70	A4J70		63	5019006.63	
RM1D060D100		125	A4J125		125	5019006.125	440
RM1D200D20		25A	HSJ25	500	25	5019006.25	660
RM1D200D50		70A	HSJ70		63	5019006.63	
RM1D500D10		15A	HSJ15		16	5019006.16	



▶ Connection diagrams

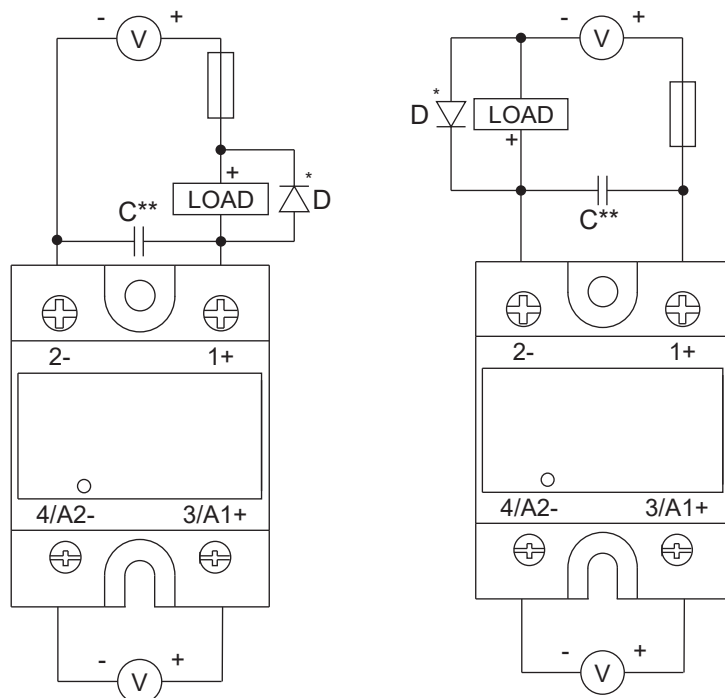


Fig. 9 RM1D connection diagrams

\* A suppressor diode D is required for inductive loads.

\*\* Applicable only to RM1D200.. and RM1D500..

The wiring cables in a DC system act as an inductor and upon switching of the load, voltage transients exceeding the max. SSR voltage may result, leading to SSR damage. The RM1D output is protected with an internal transil, however, this internal component is not intended for repetitive operation as may happen in situations with repetitive voltage transients (for example with high switching frequencies). The internal transil will fail prematurely. Hence, for the **RM1D200D..** and **RM1D500D..** models, when used at switching frequencies >1Hz it is strongly recommended to connect capacitor C across the SSR output as shown in Fig. 9 to protect the SSR output from damages resulting from uncontrolled transients. The sizing of capacitor C depends on the length of the cables in the system, the distance between the cables and the cross sectional area. Cable wiring lengths should be kept as short as possible.

Capacitor C is not necessary (even at high switching frequencies) if the voltage transients can be controlled and cannot exceed the absolute maximum voltage rating of the SSR.

**CAUTION!**

Specifically for the **RM1D200D50**, if C is required due to high switching frequencies as explained above, the absolute maximum output voltage of the SSR shall be limited to 150 VDC.

Suggested C values for a system with a total of 5 meters cable length, 0.1mm distance between cables:

- 330 nF for the **RM1D200D20** with maximum ratings of 200 VDC, 20 ADC and cables cross sectional area of 2.5 mm<sup>2</sup>
- 680 nF in series with 1 Ω (10 W) for the **RM1D200D50** with maximum ratings of 150 VDC, 50 ADC and cables cross sectional area of 10 mm<sup>2</sup>
- 68 nF for the **RM1D500D10** with maximum ratings of 500 VDC, 10 ADC and cables cross sectional area of 2.5 mm<sup>2</sup>

Capacitor voltage rating has to be 2\* voltage rating of system.

For other cable lengths and variables, please consult a Carlo Gavazzi representative for guidance.

**Functional diagram**

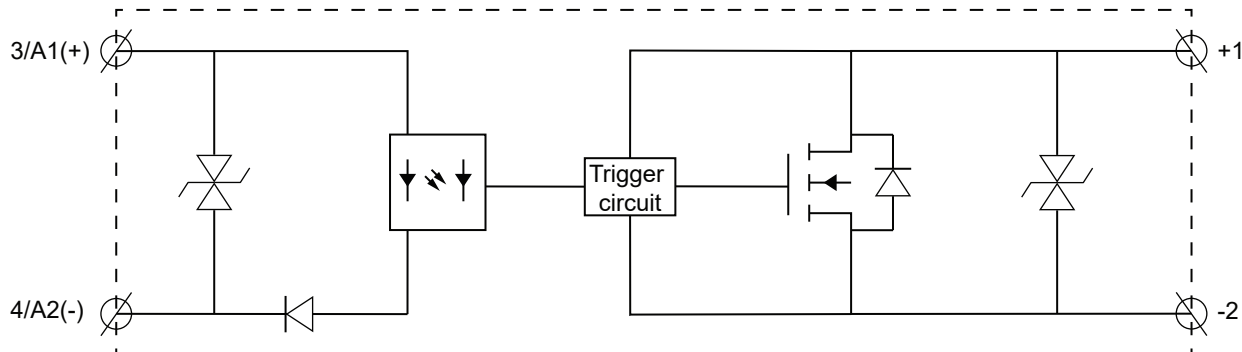
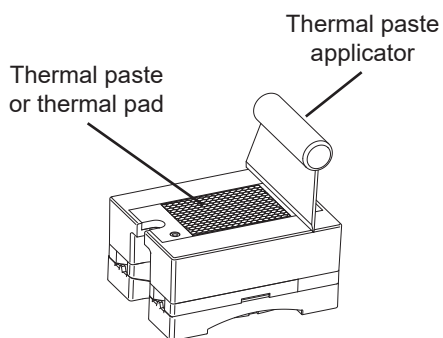
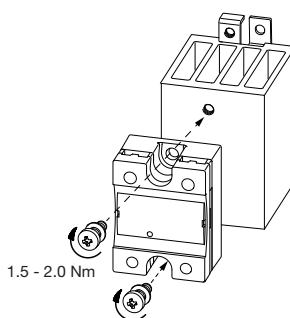


Fig. 10 RM1D functional diagram

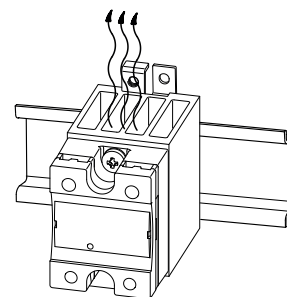
**Installation**



**Fig. 11** A fine layer of thermally conductive silicone paste shall be evenly distributed to the base of the SSR before mounting on a heat dissipator. Alternatively a thermal pad may be used. The thermal interface material affects the thermal performance. Make sure that the heatsink is sized properly.

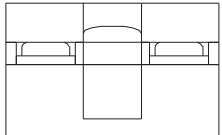
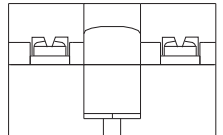
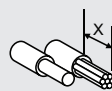





**Fig. 12** Tighten screws alternately to 0.5 Nm and then continue to max. 2.0 Nm.



**Fig. 13** Mount heatsink with fins in the vertical orientation to guarantee the best possible airflow through the heatsink.

# Connection Specifications

	1+, 2-		3/A1+, 4/A2-		
					
<b>Mounting screws (SSR to heatsink)</b>	M5, not provided with SSR (refer to SRWKITM5X10MM in the References section)				
<b>Mounting torque (SSR to heatsink)</b>	1.5 - 2.0 Nm (13.3 - 17.7 lb-in)				
<b>Conductors</b>	Use 75°C copper (Cu) conductors		Use 60/75°C copper (Cu) conductors		
<b>Stripping length, X</b>	12 mm		8 mm		
<b>Connection type</b>	M5 screw with captivated washer		M3 screw with captivated washer		
<b>Rigid (solid &amp; stranded) UR/CSA rated data</b>		1x 2.5 - 6.0 mm <sup>2</sup> 1x 14 - 10 AWG	2x 2.5 - 6.0 mm <sup>2</sup> 2x 14 - 10 AWG	1x 0.5 - 2.5 mm <sup>2</sup> 1x 18 - 12 AWG	2x 0.5 - 2.5 mm <sup>2</sup> 2x 18 - 12 AWG
<b>Flexible with end sleeve</b>		1x 1.0 - 4.0 mm <sup>2</sup> 1x 18 - 12 AWG	2x 1.0 - 2.5 mm <sup>2</sup> 2x 2.5 - 4.0 mm <sup>2</sup> 2x 18 - 14 AWG 2x 14 - 12 AWG	1x 0.5 - 2.5 mm <sup>2</sup> 1x 18 - 12 AWG	2x 0.5 - 2.5 mm <sup>2</sup> 2x 18 - 12 AWG
<b>Flexible without end sleeve</b>		1x 1.0 - 6.0 mm <sup>2</sup> 1x 18 - 10 AWG	2x 1.0 - 2.5 mm <sup>2</sup> 2x 2.5 - 6.0 mm <sup>2</sup> 2x 18 - 14 AWG 2x 14 - 10 AWG	-	-
<b>Torque specifications</b>		Pozidrive 2 2.4 Nm (21.2 lb-in)		Pozidrive 1 0.5 Nm (4.4 lb-in)	
<b>Aperture for termination lug</b>	12 mm		7.5 mm		



COPYRIGHT ©2021  
Content subject to change. Download the PDF: [www.gavazziautomation.com](http://www.gavazziautomation.com)